

55" CLASS (54.6" DIAGONAL)

55LD520C

LCD TV

LCD Commercial Widescreen Integrated Full 1080p HDTV

PUBLIC DISPLAY SETTINGS - CLONING CAPABLE

 EcoSmart™
Intelligent Sensor
Dynamic Power Savings
Static Power Savings

DYNAMIC CONTRAST RATIO
70,000:1

RESPONSE TIME 2.4ms (G to G)

NATIVE DISPLAY RESOLUTION
1920 x 1080 (full HD 1080p)

BUILT-IN ATSC/NTSC/QAM CLEAR TUNER

INVISIBLE SPEAKER SYSTEM
Hidden speaker grilles

LG'S EXCLUSIVE XD ENGINE®

USB 2.0 MEDIA HOST FOR PHOTOS AND MUSIC

USB CLONING

CLEAR VOICE II

REAL CINEMA™

3 HDMI™ INPUTS WITH HDCP
V.1.3 with deep color

2 YEAR LIMITED WARRANTY
(parts and labor)



www.LGolutions.com

 **LG**
Life's Good



green LIFE'S GOOD...

WHEN IT'S GREEN.

LG is committed to improving product development, manufacturing and usage to meet the demand for environmentally friendlier products. Our 55LD520C television has technologies to reduce power consumption and in return increase **cost savings** per room. We've also placed limits in the amounts of harmful materials used in these televisions.

EcoSmart

- Intelligent Sensor - Continually monitors room light conditions to automatically optimize the picture quality for a more enjoyable viewing experience, which can help save energy.
- Dynamic Power Savings - Using built-in algorithms, TV will automatically reduce the power consumption based on incoming video, while maximizing picture performance.
- Static Power Savings - Picture brightness level can be set at the preferred power consumption level to reduce power and increase energy savings.
- **RoHS Compliant** - Meets directive on restriction of hazardous substances.

FEATURES

ENERGY SAVING LEVELS

Manually select your choice for the brightness level for the television. By selecting Minimum, Medium, or Maximum, the power consumption will be reduced and an increase in energy savings can be achieved. (Note: Selecting minimum level may slightly increase power consumption on some models)

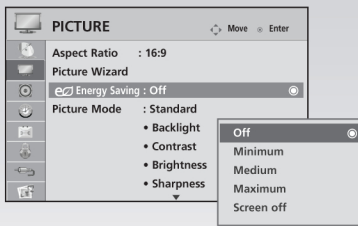

TruMotion 120Hz

TruMotion 120Hz technology lets you see sports, video games and high-speed action with virtually no motion blur. Now your TV can keep up with your fast-moving entertainment.



OFF



LOW



HIGH

Dramatization



Six distinct processes contribute to picture improvement. LG's XD Engine® takes the low resolution of analog signals to near HD levels by improving brightness, contrast, detail and enhancing color as well as reducing signal noise.



Dramatization



Dramatization



VIEWING QUALITY AS THE DIRECTOR INTENDED

24p playback matches the original frame rate of film based content, making your viewing experience one step closer to "Real Cinema".

Original Film

Original film has a frame rate of 24 frames per second. To be viewed on standard video equipment such as TVs it must be have a pull down solution.

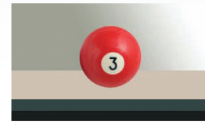

NTSC Pulldown Solution

NTSC corrects the frame rate difference by repeating every 4th frame. Sound must be separated from the film to avoid any distortion.

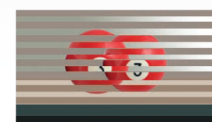

Real Cinema

Real Cinema uses a 2:3 pull down which takes every other frame and splits it into three fields of video for a smoother transition from film to video.

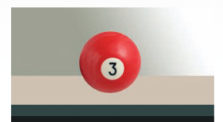

Dramatization



Automatically examines the room environment and optimizes the picture to the light and color conditions in the room for a more enjoyable viewing experience—that can also save energy and money.

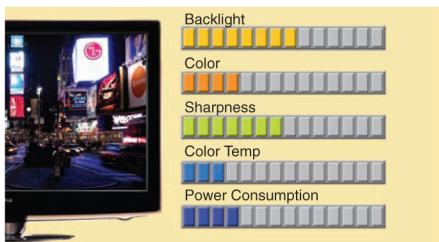

Easily connect your external USB drive to enjoy JPEG photos while listening to MP3 files at the same time for a picture slide show. Allows you to enjoy all of those family photos for a truly memorable viewing experience.



PUBLIC DISPLAY SETTINGS

When used in public areas, these HDTVs can be easily programmed by the installer to have the TV turn on at a specified channel/volume level, set the minimum/ maximum volume, lock out the control panel/remote, set the aspect ratio, and return to a factory reset. By using Power Management, these displays can be programmed to turn off if there has been no activity (remote or control panel buttons) for a preset time (1-7) hours.

Public Display Setting	
Public Display Mode	No
Start Channel	No
Ch. Type	TV
Major	2
Minor	0
Minimum Volume	0
Maximum Volume	100
Start Volume	No
Level	20
Power Management	No
Setting	1
Key Management	0
Factory Reset	0
Aspect Ratio	0

USB CLONING

USB cloning will allow for easy transfer of Public Display Settings from the "Master TV" to an unlimited number of same type televisions.

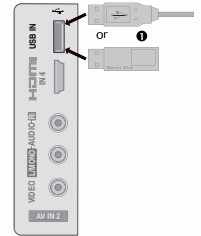

DIMENSIONS

invisible SPEAKER

SOUND IS HEARD, NOT SEEN

Enjoy a combination of smart technology and stylish design with the invisible speaker system custom tuned by audio expert Mr. Mark Levinson. This unique system provides a clean, polished look and an enhanced auditory experience by increasing the sweet spot and providing a wider sound field.

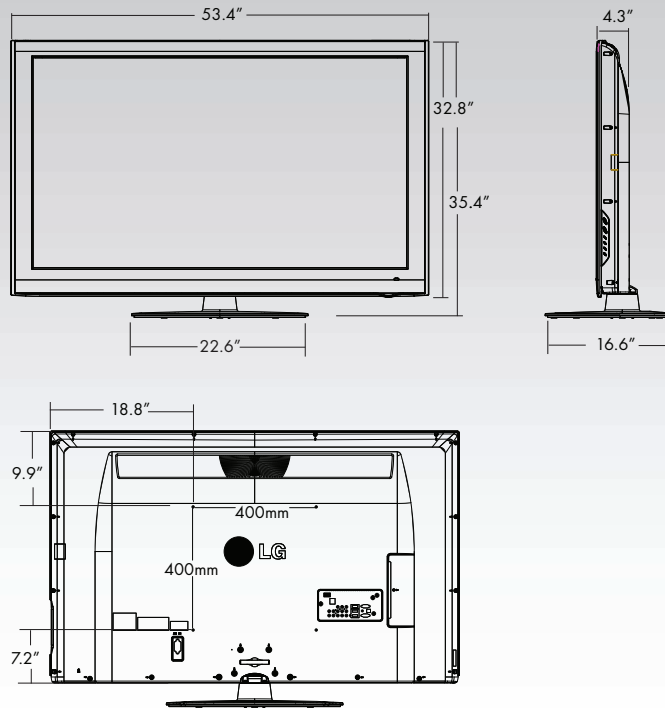

MOUNTING HOLES ON STAND ATTACHING THE TV TO A DESK

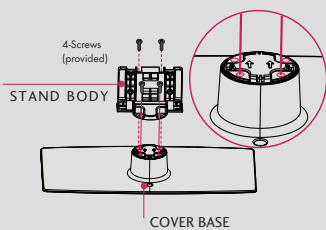

REAR

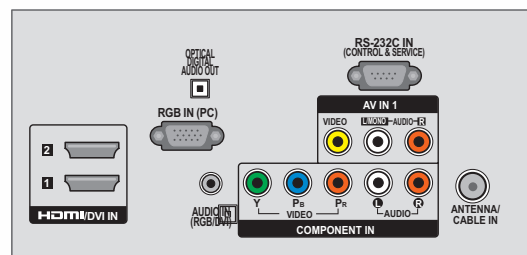

SIDE



SPECIFICATIONS

LCD SPECIFICATION

Screen Size	55" class (54.6" diagonal)
Native Display Resolution	1920 x 1080
PC Max Resolution (RGB, HDMI)	1920 x 1080
Dynamic Contrast Ratio	70,000:1
Contrast Ratio	1,400:1
Viewing Angle	178°/178°
120Hz TruMotion	Yes (except in PC mode)
Color Reproduction	10 Bit
Response Time	2.4ms (G to G)
Life Span (Typical)	60,000 hrs

BROADCASTING SYSTEM

Analog	Yes
ATSC/NTSC/Clear QAM	Yes (1 tuner)

VIDEO

XD Engine	Yes
Aspect Ratio	16:9
Aspect Ratio Correction	6 Modes
Just Scan (0% overscan)	
HDMI	1080p/1080i/720p
Component	1080p/1080i/720p
RF/DTV	1080i/720p
Enhanced Noise Reduction (Video Noise Filter)	Yes, 3D NR/MPEG NR
Digital Comb Filter	Yes (3D)
Color Temperature Control	3 Modes (Norm, Warm, Cool)
Black Stretcher	Yes
24p Real Cinema	Yes
Cinema 3:2/2:2 Mode	Yes
Picture Reset	Yes
AV Mode II (Picture & Sound)	3 Modes (Cinema, Sport, Game)
Picture Mode	Yes (8 modes)
DTV Signal Strength Indicator	Yes
Video Reset/Initializing	Yes

AUDIO

Mono/Stereo/Dual (MTS/SAP)	Yes
Audio Output Power (Watts - THD 10%)	10W x 2
Invisible Speaker System Details	1 Way 2 Speaker
Dolby Digital 5.1 Decoder	Yes
Surround System Type	SRS TruSurround XT
Bass/Treble/Balance Controls	Yes
Clear Voice II	Yes
Auto Volume Leveler	Yes
Sound Mode	5 Modes

SPECIAL FEATURES

Public Display Settings	Yes, V2.6
Brightness Optimization	Yes (Available in Standard, Natural, Sport, Game, Expert 1, & Expert 2 modes)
Picture Wizard	Yes
Backlight Control	Yes
Video Mute	Yes
USB Cloning	Yes
1080p Source Input	
HDMI	60p/30p/24p
Component	60p/30p/24p
RGB	60p
A/V Input Navigation	Yes
Input Labeling/Sub-title	Yes
Quick View (Previous Channel)	Yes
Quick Setup Guide	Yes
Simple Manual	Yes
Parental Control w/V-Chip	Yes
Key Lock/Child Lock	Yes
Customizable Closed Caption/Sub-title	Yes
LG SIMPLINK (HDMI CEC)	Yes
Screen Adjust/Auto (manual) Configure	Yes

CONVENIENCE FEATURES

Language	English/Spanish/French/Korean
Alvin UI	Yes
Auto & Manual Tuning/Programming	Yes
Channel Add/Delete	Yes
Channel Labeling	Yes
Favorite Channel Programming	Yes
Auto/Manual Clock	Yes
On/Off Timer	Yes
Sleep Timer	Yes
Auto Off/Auto Sleep (When no video is present)	Yes

AUDIO/VIDEO INPUTS/OUTPUTS

RF In (Antenna/Cable)	1
L/R Audio/Composite Video In	1 (rear), 1 (side)
HD Component Video In (Y, Pb, Pr) + L/R Audio	2
Digital Audio Out (Optical)	1
HDMI/HDCP Input (V1.3 with Deep Color)	2 (rear), 1 (side)
RGB In (D-Sub 15pin) - PC	1
PC Audio Input	1
RS-232c In	1 (Control/Service)
USB 2.0 Input	1 (Side) Media Host (JPEG, MP3), Cloning, and Service

CABINET/ACCESSORIES

Cabinet Color	Glossy Black
Swivel Stand (degrees)	+20°/-20°
Mechanical Power Off	Yes
Fire Retardant Cabinet Material	Yes
VESA® Standard Mount Compliant (WxH)	400mm x 400mm
Kensington Security System Slot	Yes
Power Indicator	Yes (red - Standby, Blue - On)
Remote Control	Yes

POWER

Voltage, Hz	100V - 240V, 50/60 Hz
Stand-by Mode (typ.)	0.3W
Power Consumption (typ.)	17.5W
EcoSmart - Energy Savings	Yes (Intelligent Sensor, Static/Dynamic Power Savings)

RoHS Compliant

Yes

DIMENSIONS & WEIGHT

TV without stand (WxHxD)	53.4" x 32.8" x 4.3"
TV with stand (WxHxD)	53.4" x 35.4" x 16.6"
Shipping Dimensions (WxHxD)	56.7" x 39.3" x 20.6"
TV without stand weight	72.5 lbs.
TV with stand weight	80.2 lbs.
Shipping Weight	97.4 lbs.

SERVICE/LIMITED WARRANTY

UPC CODE	
55LD520C	7 19192 90175 9

www.LGolutions.com

LG Electronics U.S.A., Inc.
Business Solutions Division
2000 Millbrook Drive
Lincolnshire, IL 60069

Customer Service: 888.865.3026
www.LGolutions.com/support

Contact your LG Regional Sales Representative
Vertical Markets: 800.897.8788
Channel: 800.897.8871
Hospitality: 800.228.1236
E-mail: info@LGolutions.com



LG
Life's Good

SPEC_55LD520C_061047_PR



All screen images are simulated. Dimensions and weights are approximate. Design, features and specifications subject to change without notice.

© Copyright 2010 LG Electronics USA, Inc. All Rights Reserved. "LG Life's Good" is a registered trademark of LG Corp. XD Engine is a registered trademark of LG Electronics, Inc. HealthView and EcoSmart are trademarks of LG Corp. Dolby and the double-D symbol are registered trademarks of Dolby Laboratories. SRS and the SRS symbol and TruSurround XT are trademarks or registered trademarks of SRS Labs, Inc. VESA is a trademark of Video Electronics Standards Association. All other product and brand names are trademarks or registered trademarks of their respective companies.

Printed in the USA. July 2010