

37" CLASS (37.0" DIAGONAL)

37LD310H

32" CLASS (31.5" DIAGONAL)

32LD310H

LCD TV

LCD Commercial Widescreen

Integrated HDTV with Integrated Pro:Idiom®



 EcoSmart™  
Dynamic Power Savings  
Static Power Savings

 RoHS COMPLIANT

ENERGY STAR® 4.1 COMPLIANT

INTEGRATED Pro:Idiom

MPEG-2/MPEG-4 H.264 DECODING

DYNAMIC CONTRAST RATIO  
60,000:1

NATIVE DISPLAY RESOLUTION  
1920 x 1080 Full HD (37" class)  
1366 x 768 (32" class)

BUILT-IN ATSC/NTSC/QAM CLEAR TUNER

Pro:Centric™ LITE

INVISIBLE SPEAKER SYSTEM  
Hidden speaker grilles

LG'S EXCLUSIVE XD ENGINE®

USB 2.0 MEDIA HOST FOR PHOTOS AND MUSIC

USB CLONING

CLEAR VOICE II

SPLASH IMAGE ON START UP

REAL CINEMA™

2 HDMI™ INPUTS WITH HDCP  
V.1.3 with deep color

2 YEAR LIMITED WARRANTY  
(parts and labor)

[www.LGolutions.com](http://www.LGolutions.com)



**LG**  
Life's Good



green LIFE'S GOOD...

# WHEN IT'S GREEN.

LG is committed to improving product development, manufacturing and usage to meet the demand for environmentally friendlier products.

The LD310H series has technologies to reduce power consumption and in return increase **cost savings** per room. We've also placed limits on the amounts of harmful materials used in these televisions.

- **EcoSmart**  
Dynamic Power Savings - Using built-in algorithms, the TV will automatically reduce the power consumption based on incoming video, while maximizing picture performance.  
Static Power Savings - Picture brightness level can be set at the preferred power consumption level to reduce power and increase energy savings.
- **RoHS Compliant**  
Meets directive on restriction of hazardous substances.
- **Energy Star 4.1 Qualified** - Meets current reduction requirements of energy consumption.

# FEATURES

## USB 2.0 MEDIA HOST

USB 2.0 will support JPG and MP3 files from a USB storage device.

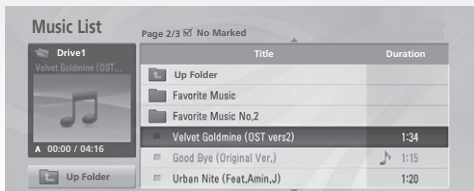
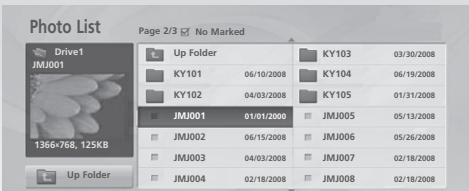
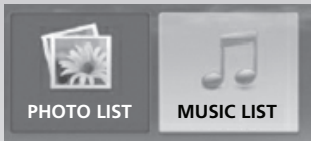

**MPEG-4 TECHNOLOGY** (Moving Picture Experts Group)  
MPEG-4 decodes and delivers high-definition programming it receives via satellite. The advanced coding system is compatible with national and local HD channels, along with digital HD channels currently launched by DIRECTV. LG built this technology into its LD310H series TVs to deliver pure HD without the need for an external box\*.

\* Certain functions, such as Pay-Per-View, may require a set-top box.

## FREE-TO-GUEST

FREE-TO-GUEST TECHNOLOGY

Will allow viewing of HD FTG secured Pro:Idiom encrypted content from Pro:Idiom licensed Cable or Satellite providers.

## ENERGY SAVING LEVELS

By selecting lower levels of backlight settings, a reduction in power consumption is achieved resulting in energy savings and lower costs.

TESTING CONDITION: PWM Static mode (eyecare off)

| Applied Model | Backlight Setting Value | Power Consumption [Watts] | Energy savings [%] |
|---------------|-------------------------|---------------------------|--------------------|
| 37LD310H      | Level 100               | 89                        | 0%                 |
|               | 90                      | 84                        | 5%                 |
|               | 80                      | 78                        | 12%                |
|               | 70                      | 72                        | 19%                |
|               | 60                      | 66                        | 25%                |
|               | 50                      | 61                        | 31%                |
|               | 40                      | 57                        | 36%                |
|               | 30                      | 52                        | 41%                |
|               | 20                      | 48                        | 46%                |
|               | 10                      | 44                        | 51%                |
| 32LD310H      | Level 100               | 73                        | 0%                 |
|               | 90                      | 64                        | 13%                |
|               | 80                      | 59                        | 20%                |
|               | 70                      | 54                        | 27%                |
|               | 60                      | 44                        | 39%                |
|               | 50                      | 41                        | 43%                |
|               | 40                      | 39                        | 47%                |
|               | 30                      | 36                        | 50%                |
|               | 20                      | 34                        | 54%                |
|               | 10                      | 31                        | 58%                |
| 1             | 29                      | 61%                       |                    |

Note: Energy Saving percentages listed are percentages off of level 100.

## Pro:Idiom®

### DIGITAL RIGHTS MANAGEMENT SYSTEM

The Pro:Idiom system's high-quality security unlocks access to premium content availability to help assure rapid, broad deployment of HDTV and other high value digital content. Pro:Idiom has been designed specifically for industries that use premium HDTV content from cable, satellite or video on demand (VOD) services and as such, could result in lower costs, and reduced maintenance. This system is one of the leading DRM systems embraced by content providers for both of these key programming sources. By using this embedded approach, security is provided and helps eliminate the possibility of customers tampering with or removing needed components.

# XD<sup>®</sup> ENGINE

SHARPER  
BRIGHTER  
CLEARER



Dramatization



Dramatization

Six distinct processes contribute to picture improvement. LG's XD Engine takes the low resolution of analog signals to near HD levels by improving brightness, contrast, detail and enhancing color as well as reducing signal noise.

## invisible SPEAKER

### SOUND IS HEARD, NOT SEEN

Enjoy a combination of smart technology and stylish design with the invisible speaker system custom tuned by audio expert Mr. Mark Levinson. This unique system provides a clean, polished look and an enhanced auditory experience by increasing the sweet spot and providing a wider sound field.



### USB CLONING

USB cloning will allow for easy transfer of Commercial Installer Menu Settings from the "Master TV" to an unlimited number of same type televisions.

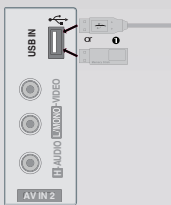

### MOUNTING HOLES ON STAND ATTACHING THE TV TO A DESK

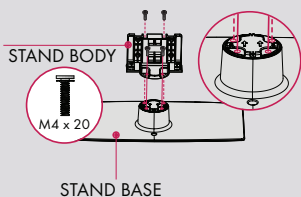

# DIMENSIONS

### 37LD310H

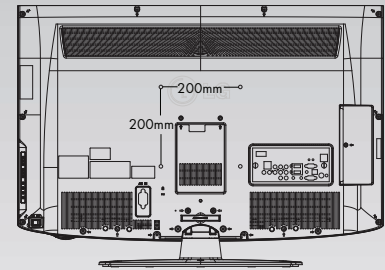
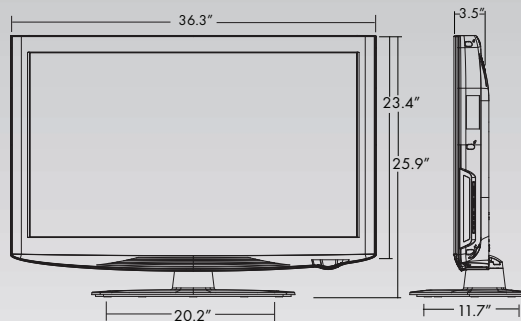

### 32LD310H

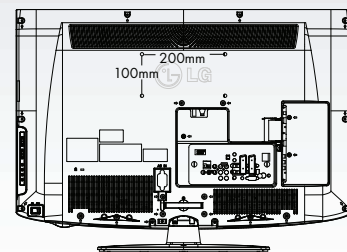
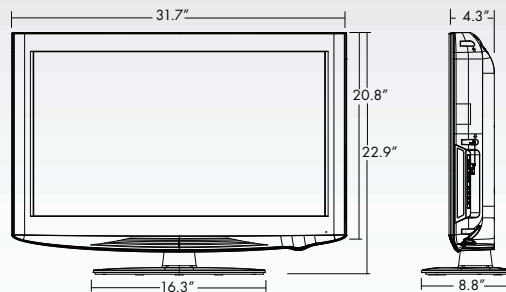

### MPI SLOT REAR JACK PANEL

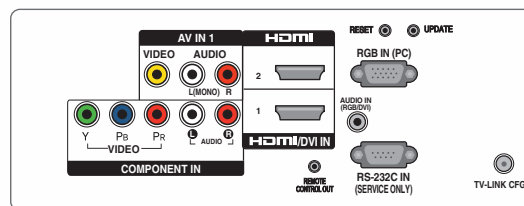

### SIDE JACK PANEL



37LD310H

37" CLASS (37.0" DIAGONAL)

32LD310H

32" CLASS (31.5" DIAGONAL)

## SPECIFICATIONS

**LCD SPECIFICATION**

|                           |  |
|---------------------------|--|
| Screen Size (Class)       | 37" class (37.0" diagonal)<br>32" class (31.5" diagonal) |
| Native Display Resolution | 1920 x 1080 (37"), 1366 x 768 (32")                      |
| Dynamic Contrast Ratio    | 60,000:1   |
| Viewing Angle             | 178°/178°  |
| Color Reproduction        | 8 Bit  |
| Response Time             | 4ms  |
| Life Span (Typical)       | 60,000 hrs   |

**BROADCASTING SYSTEM**

|                     |     |
|---------------------|-----|
| Analog              | Yes |
| ATSC/NTSC/Clear QAM | Yes |

**VIDEO**

|   |                              |
|---|------------------------------|
| XD Engine                                     | Yes                          |
| Video Codec                                   | MPEG-2/4                     |
| Aspect Ratio                                  | 16:9                         |
| Aspect Ratio Correction                       | 5 Modes                      |
| Just Scan 0% over scan                        |                              |
| HDMI/Component:                               | HD/DTV                       |
| Enhanced Noise Reduction (Video Noise Filter) | Yes, 3D NR/MPEG NR           |
| Digital Comb Filter                           | Yes (3D)                     |
| Color Temperature Control                     | 3 Modes (Medium, Warm, Cool) |
| Black Stretcher                               | Yes                          |
| 24p Real Cinema                               | Yes                          |
| Cinema 3:2/2:2 Mode                           | Yes                          |
| Picture Reset                                 | Yes                          |
| EZ Picture/PSM                                | Yes (6 mode)                 |
| xVCC (richer color)                           | Yes                          |
| DTV Signal Strength Indicator                 | Yes                          |
| Video Reset/Initializing                      | Yes                          |

**AUDIO**

|                                  |                 |
|----------------------------------|-----------------|
| Mono/Stereo/Dual (MTS/SAP)       | Yes             |
| Audio Output Power               | 10W x 2         |
| Invisible Speaker System Details | 1 Way 2 Speaker |
| Dolby Digital 5.1 Decoder        | Yes             |
| Surround System Type             | Infinite Sound  |
| Bass/Treble/Balance Controls     | Yes             |
| Clear Voice II                   | Yes             |
| Auto Volume Leveler              | Yes             |
| EZ Sound Mode/SSM                | 5 Modes         |

**SPECIAL FEATURES**

|                                       |             |
|---------------------------------------|-------------|
| Integrated Pro:Idiom                  | Yes         |
| Backlight Control                     | Yes         |
| USB Cloning                           | Yes         |
| 1080p Source Input                    |             |
| HDMI                                  | 60f/30f/24f |
| Component                             | 60f/30f/29f |
| Auto Screen Adjust                    | Yes         |
| Fresh White                           | Yes         |
| Flashback (Previous Channel)          | Yes         |
| Quick Setup Guide                     | Yes         |
| Parental Control w/V-Chip             | Yes         |
| Key Lock/Child Lock                   | Yes         |
| Customizable Closed Caption/Sub-title | Yes         |

**CONVENIENCE FEATURES**

|                          |                               |
|--------------------------|-------------------------------|
| Language                 | English/Spanish/French/Korean |
| Alvin UI                 | Yes                           |
| Commercial Function Menu | Yes                           |
| Auto Tuning/Programming  | Yes                           |
| Channel Add/Delete       | Yes                           |
| Auto/Manual Clock        | Yes                           |
| On/Off Timer             | Yes                           |
| Sleep Timer              | Yes                           |

**AUDIO/VIDEO INPUTS/OUTPUTS**

|   |   |
|---|---|
| RF In (Antenna/Cable)                         | 1   |
| L/R Audio/Composite Video In                  | 1 (rear), 1 (side)                                |
| HD Component Video In (Y, Pb, Pr) + L/R Audio | 1   |
| HDMI/HDCP Input (V1.3 with Deep Color)        | 2 (1 port PC mode)                                |
| RGB In (D-Sub 15pin) - PC                     | 1 (up to WXGA)                                    |
| PC Audio Input                                | 1   |
| RS-232c In (Service Only)                     | 1   |
| USB 2.0 Input                                 | 1 (Side) Media Host (jpeg, mp3), Cloning, Service |

|                         |                    |
|-------------------------|--------------------|
| Remote Control Port out | 1                  |
| MPI Jack (RJ-12)        | 1 on MPI Card Slot |

**CABINET/ACCESSORIES**

|                                   |  |
|-----------------------------------|--|
| Cabinet Color                     | Glossy Black   |
| Swivel Stand (degrees)            | 90°/90°  |
| Fire Retardant Cabinet Material   | Yes  |
| Kensington Security System Slot   | Yes  |
| Security Screws (TORX)            | Yes (optional use)   |
| VESA <sup>®</sup> Compliant (WxH) | 200mm x 200mm, M6 screw (37")<br>200mm x 100mm, M4 screw (32") |

|                 |   |
|-----------------|---|
| Remote Control  | Yes                                       |
| Cloning Capable | USB input, opt. LT2002, or opt. TLL-1100A |

**POWER**

|  |  |
|--|--|
| Voltage, Hz  | 100V - 240V, 50/60 Hz                              |
| Stand-by Mode  | Less than 1W                                       |
| Dynamic/Static Power Savings                         | Yes  |
| Power Consumption (with Power Saving Modes disabled) | Max. 150 (32") 200 (37")<br>Typ. 80 (32") 90 (37") |
| ENERGY STAR 4.1 Compliant                            | Yes  |
| RoHS Compliant                                       | Yes  |

**DIMENSIONS & WEIGHT**

|                             |   |
|-----------------------------|---|
| TV without stand (WxHxD)    | 31.7" x 20.8" x 4.3" (32")<br>36.3" x 23.4" x 3.5" (37")  |
| TV with stand (WxHxD)       | 31.7" x 22.9" x 8.8" (32")<br>36.3" x 25.9" x 11.7" (37") |
| Shipping Dimensions (WxHxD) | 38.8" x 24.4" x 7.6" (32")<br>47.0" x 25.9" x 9.0" (37")  |
| TV without stand weight     | 25.1 lbs (32")<br>29.0 lbs (37")                          |
| TV with stand weight        | 27.7 (32")<br>33.0 (37")                                  |
| Shipping Weight             | 32.3 (32")<br>40.0 (37")                                  |

**SERVICE/LIMITED WARRANTY**

|          |                       |
|----------|-----------------------|
| UPC CODE | 2 Years (Parts/Labor) |
|----------|-----------------------|

|          |                 |
|----------|-----------------|
| 37LD310H | 7 19192 90199 5 |
| 32LD310H | 7 19192 90198 8 |



www.LG.com

LG Electronics U.S.A., Inc.  
Business Solutions Division  
2000 Millbrook Drive  
Lincolnshire, IL 60069

Customer Service: 888.865.3026  
www.LG.com/support

Contact your LG Regional Sales Representative:  
Vertical Markets: 800.897.8788  
Channel: 800.897.8871  
Hospitality: 800.228.1236  
E-mail: info@LG.com



**LG**  
Life's Good

SPEC\_32\_37LD310H\_101002\_PR

Printed in the USA. December 2010

All screen images are simulated. Dimensions and weights are approximate. Design, features and specifications subject to change without notice.

© Copyright 2010 LG Electronics USA, Inc. All Rights Reserved. "LG Life's Good" is a registered trademark of LG Corp. XD Engine, Pro:Centric and EcoSmart are registered trademarks or trademarks of LG Electronics, Inc. Pro:Idiom is a registered trademark of Zenith Electronics Corp. SRS and the SRS symbol and TruSurround XT are trademarks or registered trademarks of SRS Labs, Inc. VESA is a trademark of Video Electronics Standards Association. ENERGY STAR is a registered trademark of the U.S. Environmental Protection Agency. All other product and brand names are trademarks or registered trademarks of their respective companies.